

ECMM Series For USB 3.0,

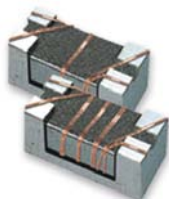

Based on Chilisin's technical expertise, we have introduced a full series of common mode choke. They are designed for excellent noise attenuation with a compact size for wide applications such as USB line for personal computers and peripheral, DVC, STB and LVDS, panel line for liquid display panels, etc. We welcome you to contact us for requirement of our standard series or custom design service.

Features Applications

- RoHS Compliant
- Miniature SMD type common mode filter for fully automated assembly.
- Excellent Solderability.

Applications

- USB3.0

Product Identification

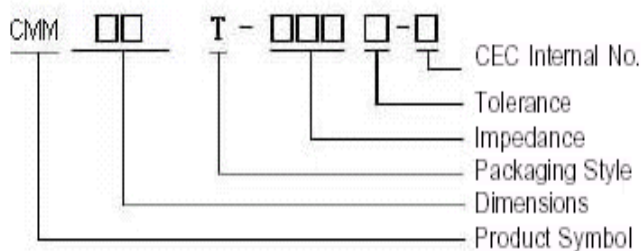

- Packaging: T : Tape and Reel

Shapes and Dimensions

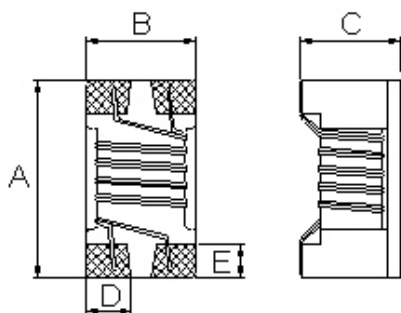

Dimensions in mm

TYPE	A	B	C	D	E
ECMM11	1.25±0.2	1.00±0.2	0.8±0.1	0.32	0.33

Recommended Pattern

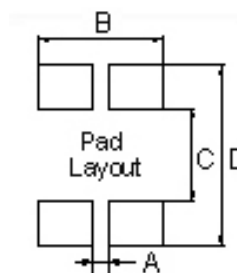

Dimensions in mm

TYPE	A	B	C	D
ECMM11	0.36	1.00	0.59	1.75

SMD Common Mode Choke - ECMM Series

Electrical Characteristics

Part Number	Impedance (Ω)	Test Frequency (MHz)	Tolerance (±%)	I _{dc} (mA) Max	Rated Voltage (V _{dc})	R _{dc} (Ω) Max	Insulation Resistance (MΩ) Min
ECMM11T-600M-N	60	100	20	300	20	0.40	10
ECMM11T-670M-N	67	100	20	300	50	0.25	10
ECMM11T-900M-N	90	100	20	250	50	0.30	10
ECMM11T-121M-N	120	100	20	200	50	0.40	10
ECMM11T-161M-N	160	100	20	160	50	0.43	10

- When ordering, please specify tolerance and packaging codes. Ex:ECMM11T-600M-N
- Tolerance : M = ±20%
- Packaging : Clear tape and reel { standard }.
- Z : Agilent/HP4287A+Agilent16197A
- R_{dc}(single line) :Chroma16502
- Insulation Resistance : Agilent/HP4339B
- Operating temperature range from -40°C to 105°C. (Including self - temperature rise)

Test Instruments : HP4287A Material/Impedance Analyzer

Typical Impedance vs. Frequency

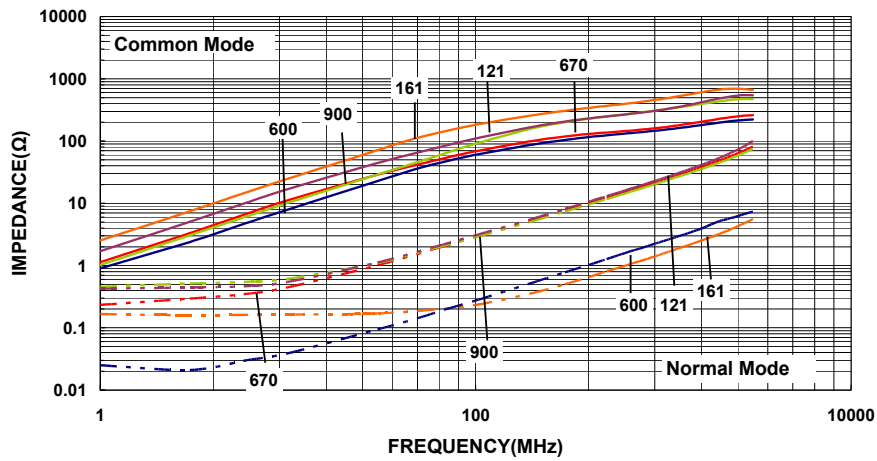

Packaging Specifications

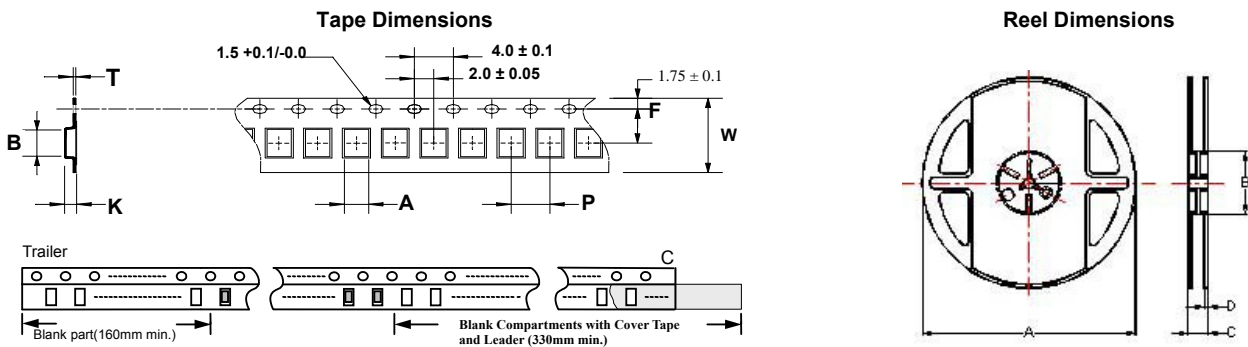

Dimensions in mm

TYPE	Tape Dimensions							Reel Dimensions				Quantity PCS / Reel
	A	B	T	W	P	F	K	A	B	C	D	
ECMM11	1.10	1.40	0.24	8	4	3.5	1.00	178	60	12	1.5	2000

ECMM Series For USB 2.0, IEEE1394b, LVDS Applications



Based on Chilisin's technical expertise, we have introduced a full series of common mode choke. They are designed for excellent noise attenuation with a compact size for wide applications such as USB line for personal computers and peripheral, IEEE 1394 line for personal computers, DVC, STB and LVDS, panel line for liquid display panels, etc. We welcome you to contact us for requirement of our standard series or custom design service.

Features Applica

- RoHS Compliant
- Miniature SMD type common mode filter for fully automated assembly.
- Wide Impedance range (30Ω ~ 2200Ω) for noise suppression.
- Excellent Solderability.
-

Product Identification

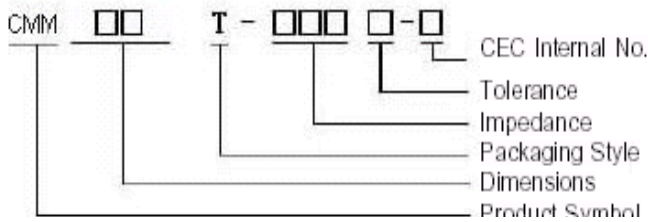

tions

- USB line for personal computers and peripheral,
- IEEE 1394 line for personal computers, DVC, STB.
- LVDS, panel line for liquid display panels, graph card etc.

- Packaging: T : Tape and Reel

Shapes and Dimensions

ECMM21

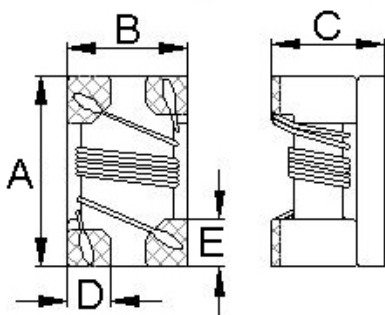

ECMM31

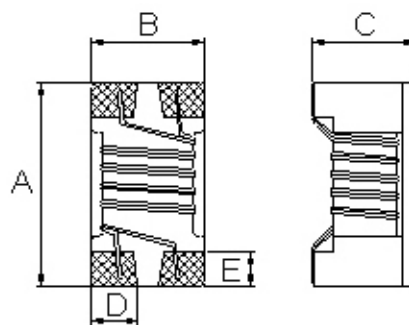

Recommended Pattern

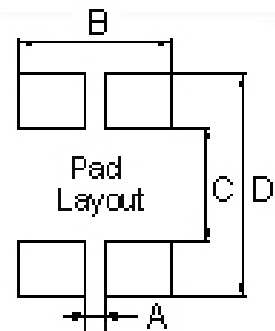

Dimensions in mm

TYPE	A	B	C	D	E
ECMM21	2.05±0.2	1.25±0.2	1.20±0.2	0.50	0.58
ECMM31	3.20±0.2	1.60±0.2	1.90±0.2	0.60	0.60

Dimensions in mm

TYPE	A	B	C	D
ECMM21	0.50	1.20	0.80	2.60
ECMM31	0.40	1.60	1.60	3.70

SMD Common Mode Choke - ECMM Series

Electrical Characteristics

Part Number	Impedance (Ω)	Test Frequency (MHz)	Tolerance ($\pm\%$)	Idc (mA) Max	Rated Voltage (Vdc)	Rdc (Ω) Max	Insulation Resistance (M Ω) Min
ECMM21T-300M-N	30	100	20	450	120	0.20	10
ECMM21T-670M-N	67	100	20	400	120	0.25	10
CMM21T-900M-N	90	100	20	330	120	0.35	10
CMM21T-121M-N	120	100	20	370	120	0.30	10
CMM21T-161M-N	160	100	20	350	120	0.35	10
CMM21T-181M-N	180	100	20	330	120	0.35	10
CMM21T-201M-N	200	100	20	330	120	0.35	10
CMM21T-221M-N	220	100	20	310	120	0.35	10
CMM21T-261M-N	260	100	20	300	120	0.40	10
CMM21T-301M-N	300	100	20	290	120	0.40	10
CMM21T-361M-N	360	100	20	280	120	0.45	10
CMM21T-371M-N	370	100	20	280	120	0.45	10
CMM21T-501M-N	500	100	20	170	120	0.55	10
CMM21T-671M-N	670	100	20	140	120	0.60	10
CMM21T-901M-N	900	100	20	80	120	0.60	10

- When ordering, please specify tolerance and packaging codes.
- Tolerance : M = $\pm 20\%$
- Packaging : Clear tape and reel { standard }.
- Z : Agilent/HP4291A
- Rdc(single line) : CH502BC/ HP4338B
- Insulation Resistance : Agilent /HP4339B
- Operating temperature range from -40°C to 105°C . (Including self - temperature rise)

Test Instruments : HP4291A Material/Impedance Analyzer

Typical Impedance vs. Frequency

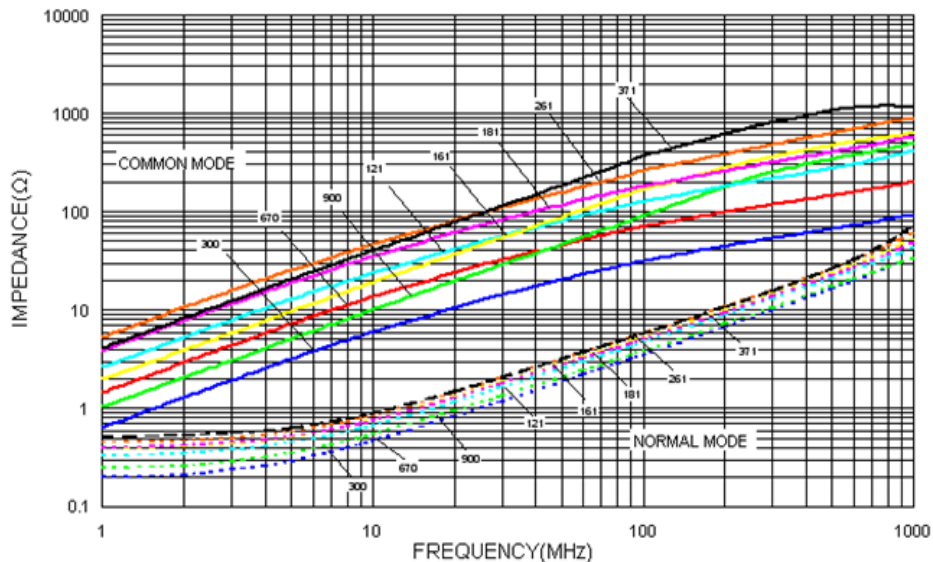

SMD Common Mode Choke - CMM Series

Electrical Characteristics

Part Number	Impedance (Ω)	Test Frequency (MHz)	Tolerance ($\pm\%$)	Idc (mA) Max	Rated Voltage (Vdc)	Rdc (Ω) Max	Insulation Resistance (M Ω) Min
CMM31T-900M-N	90	100	20	370	50	0.3	10
CMM31T-161M-N	160	100	20	340	50	0.4	10
CMM31T-221M-N	220	100	20	320	50	0.4	10
CMM31T-261M-N	260	100	20	310	50	0.5	10
CMM31T-601M-N	600	100	20	260	50	0.8	10
CMM31T-102M-N	1000	100	20	230	50	1.0	10
CMM31T-222M-N	2200	100	20	200	50	1.2	10

- Tolerance: M = $\pm 20\%$
- Packaging: Clear tape and reel {standard}
- Z: Agilent/HP4291A
- Rdc (single line): CH502BC/ HP4338B
- Insulation Resistance: Agilent/HP4339B
- Operating temperature range from -40°C to $+105^{\circ}\text{C}$. (Including self - temperature rise)

Test Instruments : HP4291A Material/Impedance Analyzer

Typical Impedance vs. Frequency

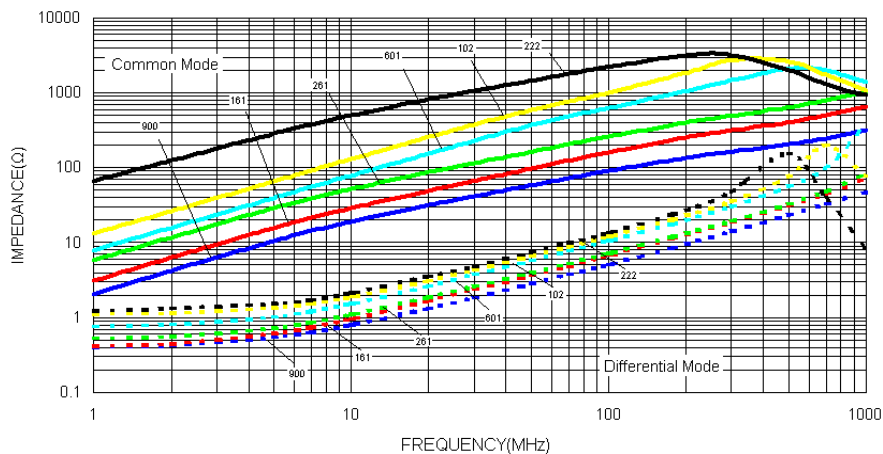

Packaging Specifications

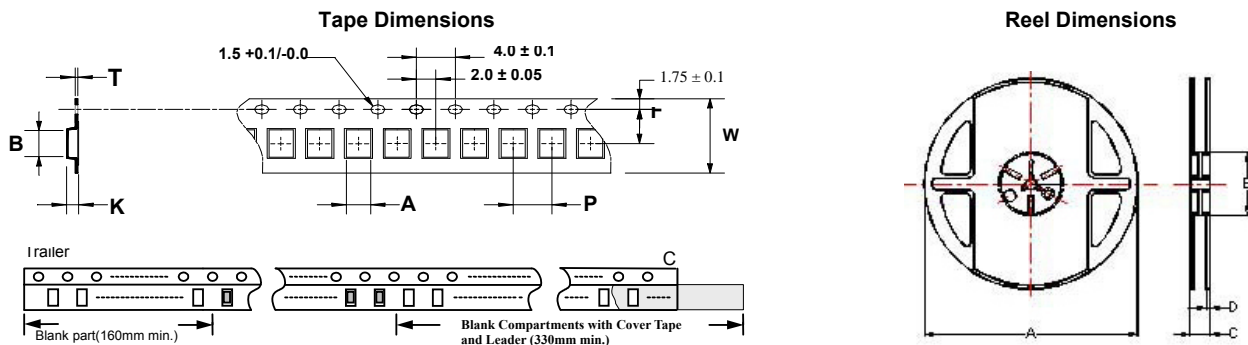

Dimensions in mm

TYPE	Tape Dimensions							Reel Dimensions				Quantity PCS / Reel
	A	B	T	W	P	F	K	A	B	C	D	
CMM21	1.50	2.25	0.24	8	4	3.5	1.45	178	60	12	1.5	2000
CMM31	1.76	3.47	0.22	8	4	3.5	2.05	178	60	12	1.5	2000